

Sommerhuber Lounger Three Plus Height 44cm

Freestanding heated lounger with ergonomically shaped, large-area heat storing ceramics and 2 transverse joints only. Velvety soft ceramic surface with optimal hygiene aspects. This heated Lounger allows for enjoyable indoor use. Thanks to specific characteristics heat storing ceramics emit mild areal infrared warmth, which enhances blood circulation and results in superior relaxation and maintaining of vitality.

Descriptive size: L/W/H ~ 171/69/111 cm

Weight: ~ 99 kg

Article no.: 652 003

Ready to plug-in product.

Available in 15 different glazes.

- EPS sub-construction, colour „offwhite“
- With static load, if fully fixed on the floor by adhesive, at standard height 22cm: Stability at the foot part max. 200 kg; Pressure resistance at backside of head part max. 125 kg. With heights 33 or 44 cm, the Lounger is to be fully fixed on the floor by adhesive and sealed properly.
- One-zone electrically heated with an EU 230V heating system (mounted), heat capacity 675W
- Thermostat IP20 for external installation
- Power supply via floor
- Surface temperature: uncovered up to max. 50°C.
Recommended temperature: ~ 34°C +/- 2°C
- Incl. cable (standard length 2,5m)
- Incl. bolster "Relax", colour „offwhite“
- Optional: LED lights, matching colour to glaze of

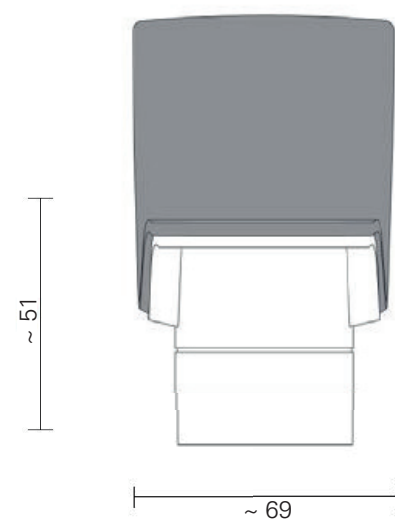
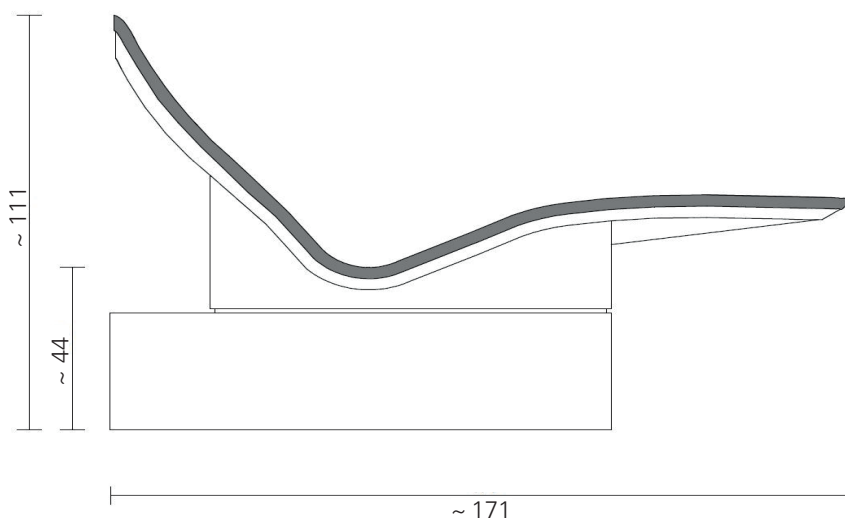

All measurements in cm

This product is maintenance free.

For proper cleaning please use only cleaning agents with PH value between 5.0 - 9.0. Please use soft cleaning clothes only. Abrasive brushes or high-pressure cleaners could damage the glazed surface.