

Sommerhuber Center part to rectangular size for water fittings

The centre part for water fittings is made of heat storing ceramic and enlarges two square foot basin to a rectangular shape. It is made in one single piece without joints, glazed inside and outside over the entire surface.

Descriptive size: L/W/H ~ 49 / 20,30 / 30 cm

Weight: ~ 13 kg

Article no.: 651 262

Available in 15 different glazes.

Please note, for technical reasons this element is not available in 318 outback, 436 sandstone medium, 458 savanna medium and 461 alabaster matt.

- To be mounted directly on the floor with stripes of silicone
- Drain tap to be built on site
- Optional sharp-edged holes according to exact measurements

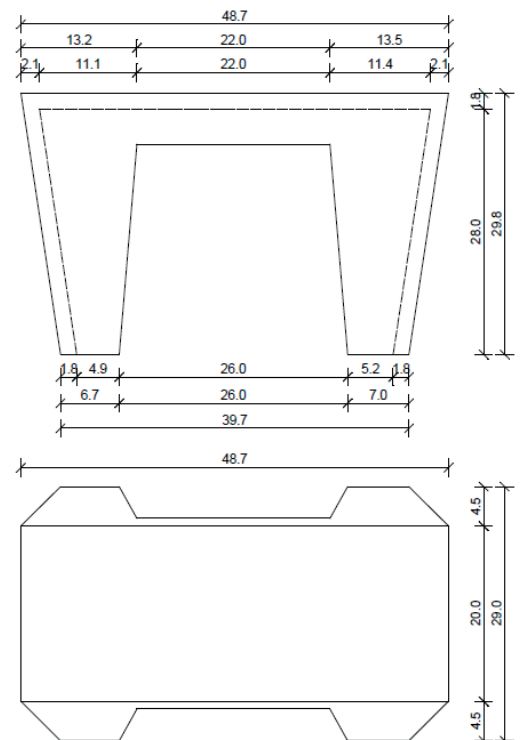
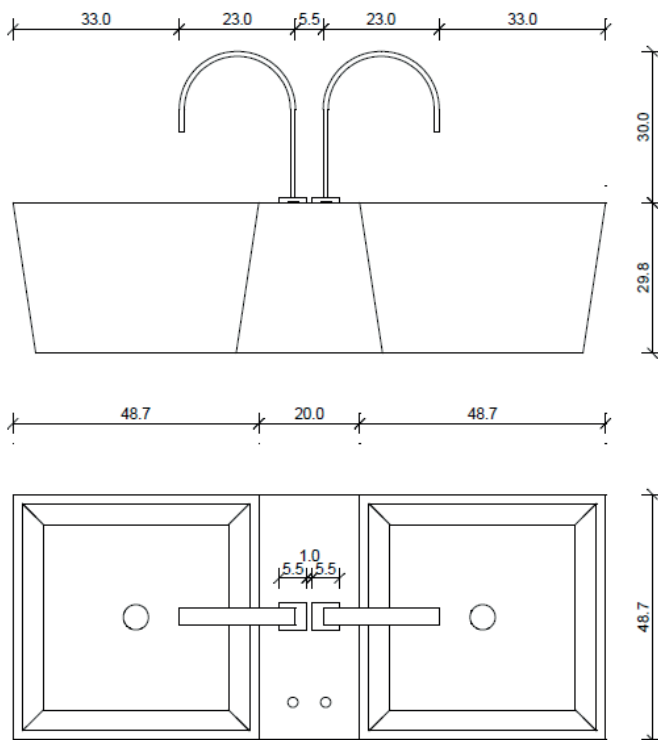

Measurements are nominal sizes.
All measurements in cm

This product is maintenance free.

For proper cleaning please use only cleaning agents with PH value between 5.0 - 9.0. Please use soft cleaning clothes only. Abrasive brushes or high-pressure cleaners could damage the glazed surface.